

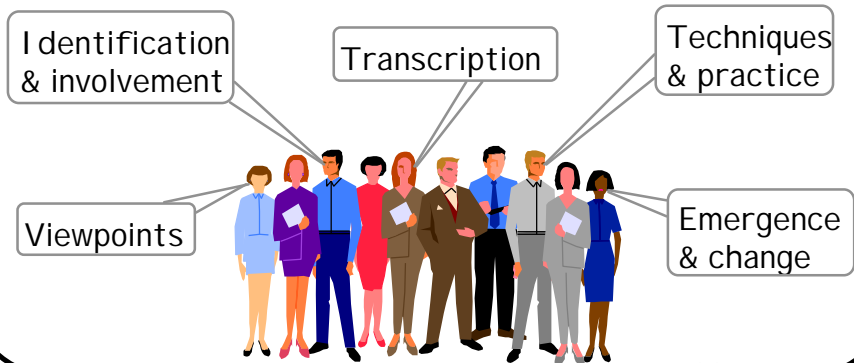

3

## Why Needs Are Not Met...

Obtain  Specify  Use



RESS '94

4

## Progress In Meeting Needs...

### Assurances?

- Reqs elicitation:
  - Obtain needs
- Reqs description:
  - Record needs
- Development methods:
  - Use needs

### Guarantees?

- Connection between elicited info, derived reqs & subsequent artifacts
- Reqs traceability:
  - Augment needs
  - Meet needs
  - Change needs

RESS '94

## Some Terminology...



"Requirements Traceability (RT) refers to the ability to describe & follow the life of a requirement in both a forwards & backwards direction"

(i.e., From its origins, through its development & specification, to its subsequent deployment & use, & through all periods of on-going refinement & iteration in any of these phases)

## Some More Terminology...

"Post-RS Traceability is concerned with those aspects of a requirement's life that result from its inclusion in the RS"

(i.e., Requirement deployment)



"Pre-RS Traceability is concerned with those aspects of a requirement's life prior to its inclusion in the RS"

(i.e., Requirement production)

### Pre-RS & Post-RS Traceability...

Reqs artifacts produced (related to production)      Reqs artifacts produced (related to deployment)

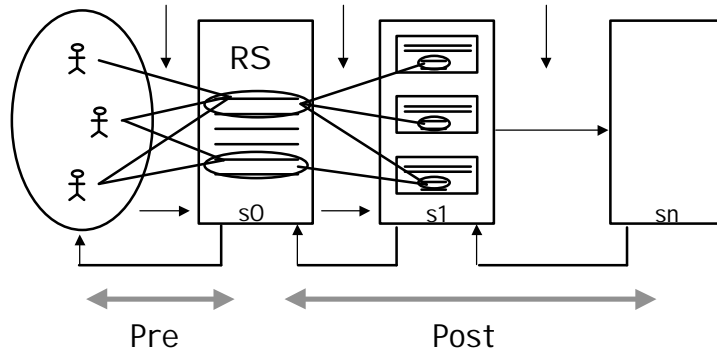

### Persistent RT Problems...

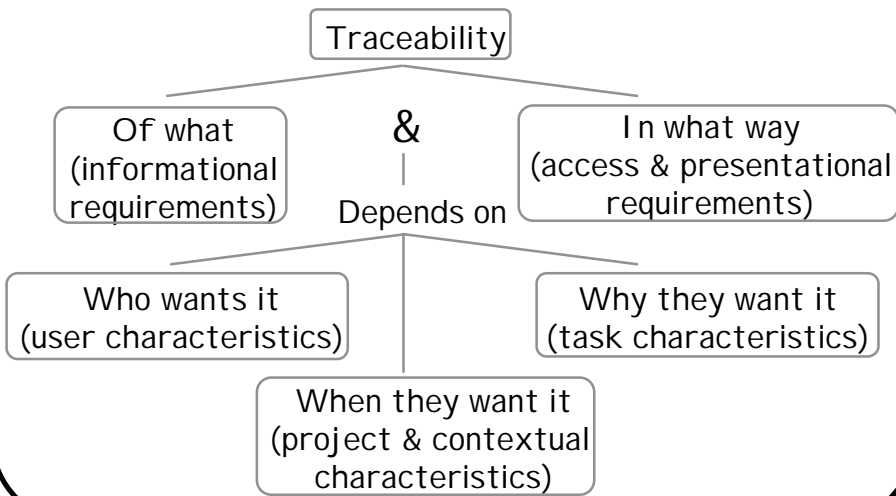

### Crux Of RT Problems...

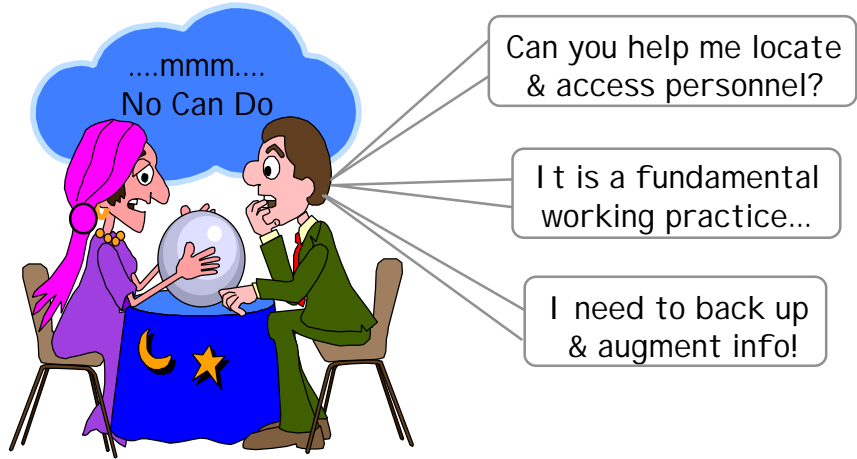

### Traceability Of Requirements Contributors & Contributions...

Model contribution structure underlying reqs:



## Our Approach (1)...

Define contribution format of artifact:



- P: agent whose position or belief is established by the information the artifact expresses
- A: agent responsible for choosing & organising the content & structure of the artifact
- D: agent responsible for physical manifestation of the artifact (i.e., captures or records it)

## Our Approach (2)...

Contribution format of artifact & internal components



PAD agents:

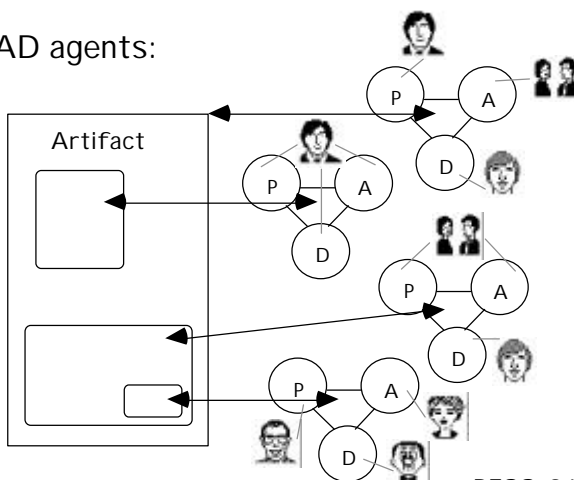

## Our Approach (3)...

Infer contribution roles of agents wrt artifact:

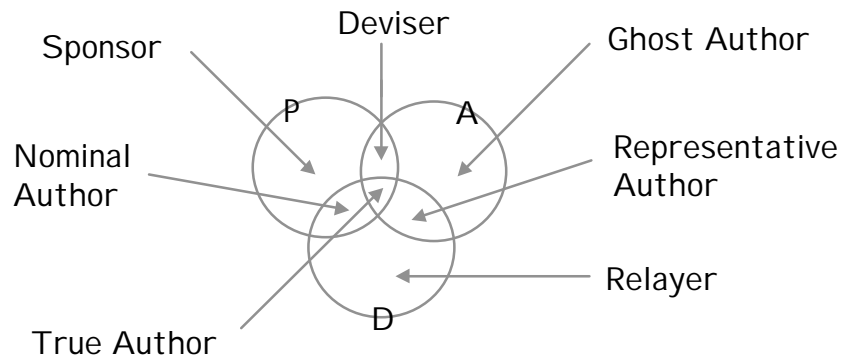

## Our Approach (4)...

Infer agent commitment to artifact

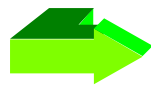

Who to involve/inform in queries/changes:

True Author:	<input checked="" type="checkbox"/> Physical appearance	<input checked="" type="checkbox"/> Anticipated/realised effect
	<input checked="" type="checkbox"/> Structural form	<input checked="" type="checkbox"/> Semantic content
Deviser:	<input checked="" type="checkbox"/> Physical appearance	<input checked="" type="checkbox"/> Anticipated/realised effect
	<input checked="" type="checkbox"/> Structural form	<input checked="" type="checkbox"/> Semantic content
Relayer:	<input checked="" type="checkbox"/> Physical appearance	<input checked="" type="checkbox"/> Anticipated/realised effect
	<input checked="" type="checkbox"/> Structural form	<input checked="" type="checkbox"/> Semantic content

## Our Approach (5)...

Infer more about types/degrees of commitment

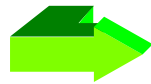

Qualify PAD status:

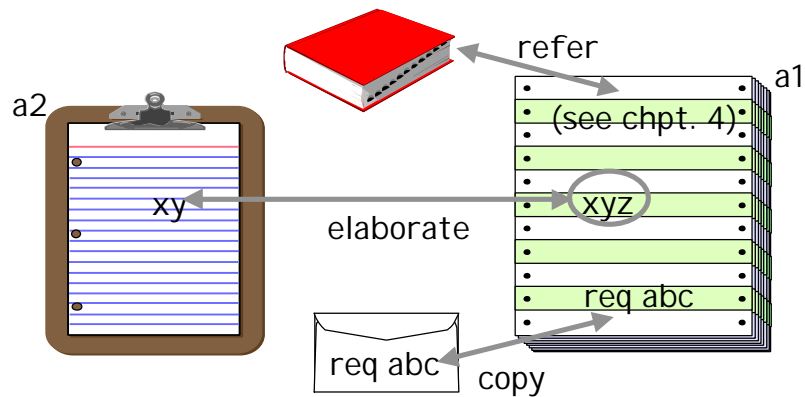

RESS '94

## Summarising...



Problem:

Tracing required details about reqs elicitation process - Hinders reqs production & refinement

Contribution structures:

Fine/rapid location of personnel to perform activities & address defects

Potential for continuous reqs (re)-definition & (re)-assessment

RESS '94



## Questions...

What elicitation details typically get documented:  
- How, when, why used/by whom?

Which techniques/tools couple details of elicitation process with end products?

Our approach: Scalable? Distinguishable?

How extract, couple & use contributor details?

How currently account for different capacities in which RE participants provide info?



Now over to you...